

Primed to Clean
Prime Line

For all Your Glasswashing
and Dishwashing Needs





 **COMENDA**



DEPENDABLE, DURABLE AND READY TO CLEAN

Practical measures and professional results – that’s precisely where our Prime line of dishwashing solutions fit into your operation.

Highly durable and adaptable to the specific needs of today's food service professionals, the entire line of Prime promotes rapid cleaning, energy efficiency and operational savings.

We back our Prime range of cleaning solutions with an unparalleled level of client service. By understanding each client's individual needs we're always prepared to develop a plan and recommend the products that fit best.

Flexible, forward-thinking and ready to respond, we earn the trust of our clients thanks to a spirit of collaboration and prompt action.

We may be a single component within your operation, but we will always consider our role critical to your continued success.



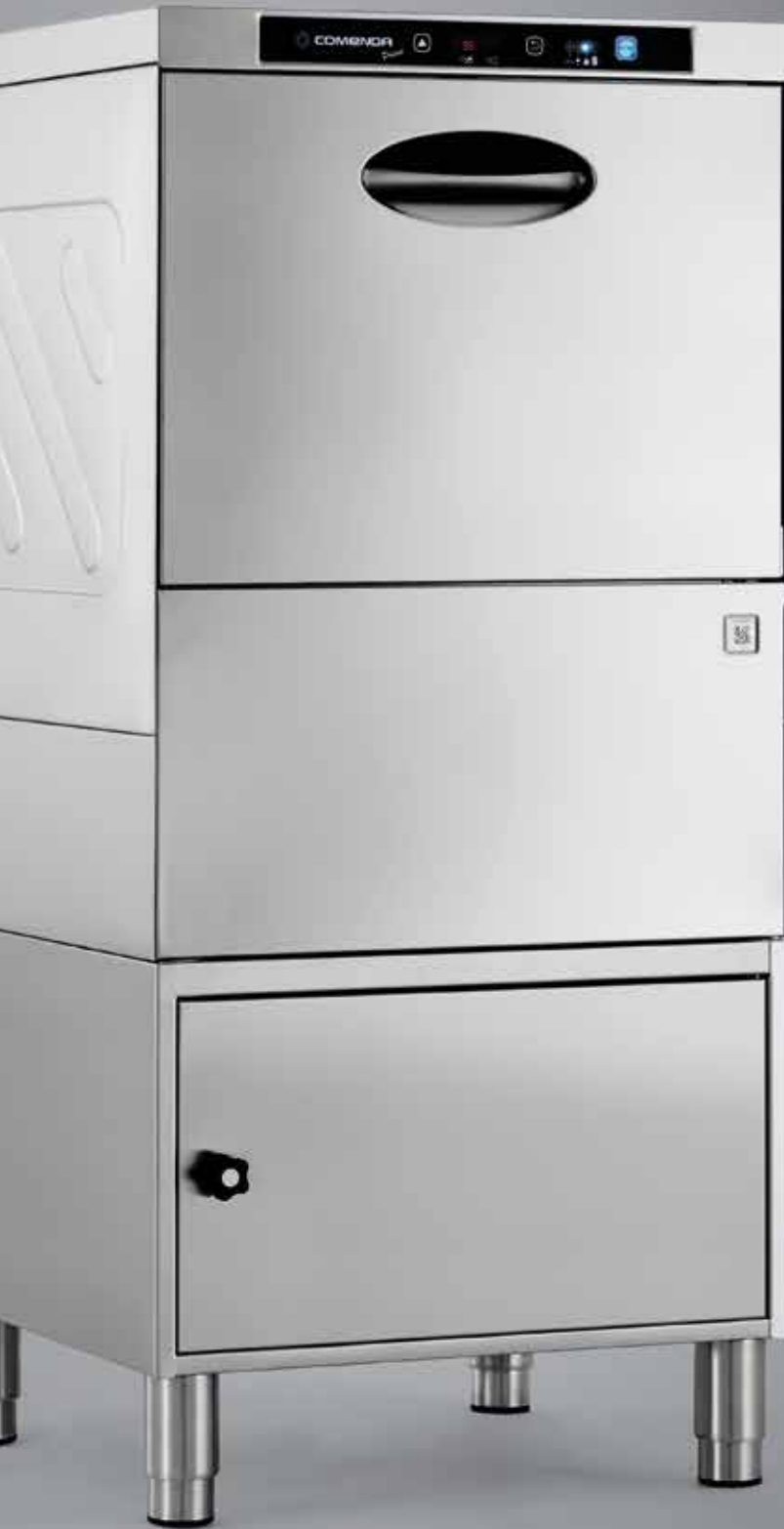

“RELIABILITY, EFFICIENCY, PRODUCTIVITY AND DURABILITY – WE TAKE INSPIRATION FROM EACH IN DESIGNING THE PRIME SERIES”

We offer a full range of accessories to meet your every need.



DESIGN

FIND YOUR PERFECT FIT

Developing equipment that can handle the rigours of high pressure hospitality operations has always been our focus, but we also emphasize the importance of adaptability and allowing you to configure each unit to your specific needs.

That means adding features to enhance your cleaning properties or saving on those that are considered unnecessary for your operation. **You get exactly what you need** in your washing system while toeing the budgetary line.

The Prime series promotes operational ease to ensure people of any stature can readily run the system, strain-free. Our **double-skinned insulated door** protects operators from the heat that the unit generates and contributes to user comfort. From powerful undercounter units that serve front of house operations to our range of workhorse hood-type models for larger capacity needs, we have the right option for you.



Full set of racks available for all types of crockery, cutlery, glassware and trays.



The inherent appeal of the Prime range is found in both its simplicity of design and functional efficiency.



CONTROL PANEL

TOUCH POINT POWER

Adaptability is at the heart of what we do and how we design. Our control panel keeps operations effortless with straightforward cycle options at your fingertips.

The intuitive user design features clear cycle monitoring, **colour-coded status indicators** as well as four different programming options for washing cycles (Eco Fast, Glasses, Dishes and Intensive) that deliver precision cleaning. The control panel also shows all functioning parameters and highlights any anomalies. This allows for easier monitoring and ensures that the machine is in full compliance with HACCP protocols.

Soft Start

This feature begins the cycle slowly and gradually builds to full speed to prevent the dislodging of glasses and crockery, and possible breakage.

Stand-by

Our automatic stand-by mode activates during pauses to reduce energy consumption.

REQUIRE A CUSTOMIZED SOLUTION?

Our trained technicians will program the control panel upon installation to establish specific times, temperatures and detergent requirements. With Comenda, you're in control.

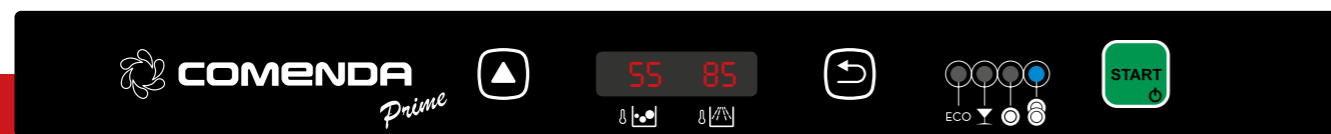

ECO FAST

For high pressure kitchen times, this is the most rapid cycle. It handles up to 65 baskets per hour for our largest model (PC12).

GLASSES

A delicate cycle that is gentle on glassware and features rapid cool down and dry times.

DISHES

Appropriate for all shapes of dishes, this cycle ensures thorough cleaning and rapid dry times.





INTENSIVE

Set for a longer duration and maximum temperature for heavily soiled dishes and cookware.

ECO



The type of service, quality of crockery and glassware, and pace of work all dictate which cycle works best.

-  Initial tank fill
-  Ready to go
-  Cycle on
-  Alarm





ENERGY EFFICIENCY

EQUIPPED TO SAVE

“Smart design is in the details. And smart design that generates greater savings for our customers is what drives us at Comenda.”

We continue to engineer efficiencies by developing cleaning technology that delivers both excellent performance and **budget-sensible results**. The Prime Line shrinks water usage and curbs heating requirements, plus it relies on fewer chemicals or detergents. That benefits your operation and is even better for your bottom line.

WRIS®2+

The smart design of our WRIS®2+ Wash and Rinse Integrated System posts a 25% reduction in rinse water consumption while still providing a thorough, consistent clean*.

Thanks to the double water blade design, the WRIS®2+ boosts contact time and leaves no blind spots as it produces brilliantly clean glasses, dishes and cutlery.

-25% water



-25% energy

-25% chemicals

Standard for PB and PF45 glass- and undercounter dishwashers and for model PC07.

* compared to our previous models



CRC2 HEAT RECOVERY SYSTEM

Our CRC2 heat recovery system and steam condenser on hood type machines uses heat already generated to warm incoming water. This permits a cold water connection while avoiding additional electric load.

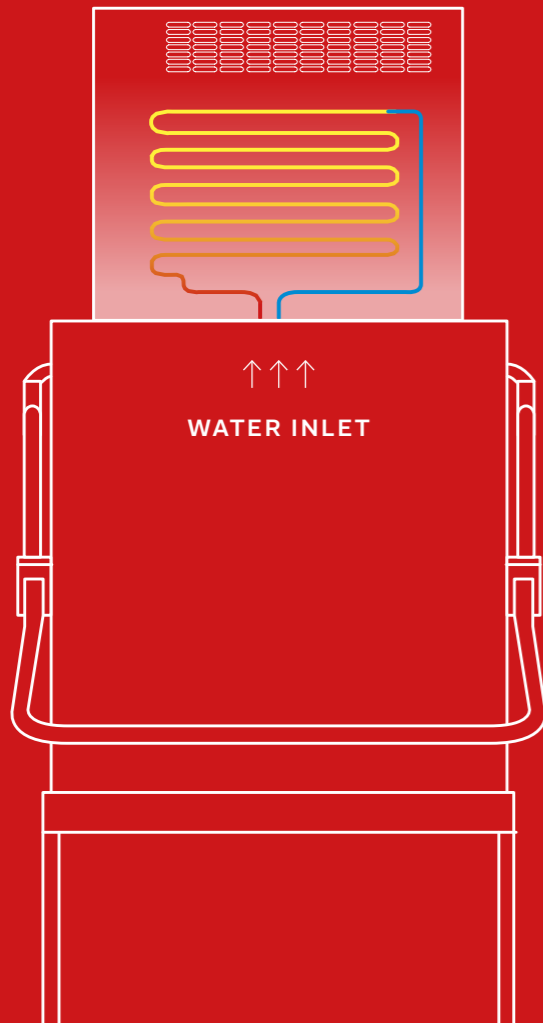

This system helps to minimize the steam released to **create a more comfortable work environment** while using the warmth of the unit to further heat incoming water and reduce energy costs. That reduction of steam in the washing chamber also contributes to speedier drying of glasses and dishes.



-35%
Energy consumption





HYGIENE

SPOTLESS REPUTATION

We've built our reputation on providing exceptional hygiene solutions for clients whose operations depend on it. Meeting the stringent demands of hospitals, health organizations and food operations around the world has laid the groundwork for the development of our key hygiene features.

Rinse Control Device (RCD)

Our Rinse Control Device combines an atmospheric boiler and a rinse booster pump to ensure consistent water pressure at a constant temperature throughout the cycle. That produces perfectly spotless glasses.

How RCD Works

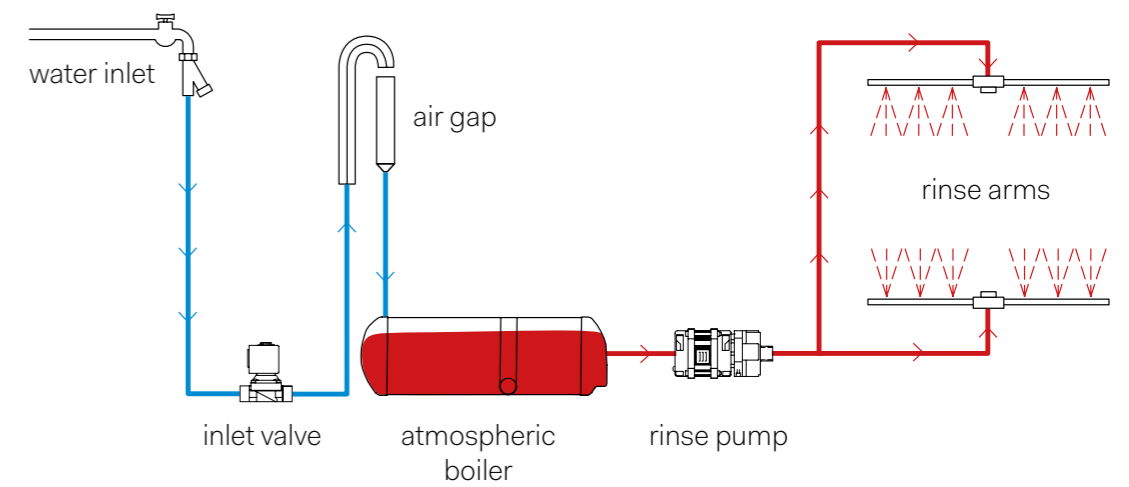



Primed to Clean

GLASSWARE

BRILLIANT RESULTS

Properly washing glasses is always a challenge.

That's why we've dedicated ourselves to designing a glasswasher that will give industry professionals greater confidence in providing brilliantly spotless glasses. With the Prime series of glasswashers, we ensure every glass is given a thorough cleaning thanks to a rinse arm configuration that reaches every point. No blind spots, no left over residue. No worries.



With Prime Line
we give you clear,
clean confidence.



EQUIPMENT CALLOUT

WHAT'S UNDER THE HOOD?

We've developed this range of cleaning solutions so that it is easier than ever to scale up the services to meet your operation's specific requirements. Options allow you to pick and choose exactly what you need while never having to pay for those features you don't require. Consider some of the optional features you can add.

HEATING UP, COOLING DOWN

Only for our hood-type machines in the Prime series, our **CRC2 system dramatically reduces steam emissions and contributes to a more comfortable work environment.** This feature condenses and cools the air released at a lower temperature. The system also leverages the heat produced by the unit to heat incoming water, which significantly cuts energy consumption.

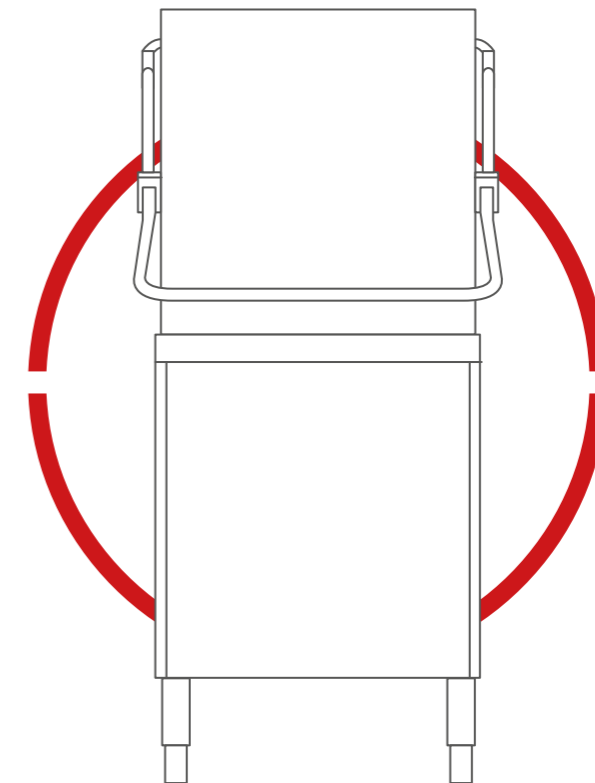

KEEP UP THE PRESSURE

The **RCD (Rinse Control Device)** ensures that **consistent water pressure is applied during the rinse phase.** The combination of an atmospheric boiler and rinse booster pump in the RCD maintains a constant temperature throughout the entire rinse cycle.

TARGETING LIMESCALE

Hard water produces limescale deposits, which over time become problematic for any operation. The gradual buildup of this hard, off-white, chalky substance impedes water flow and operational effectiveness. **Our Prime Line is available with water softeners to improve water quality and extend the life of your warewasher.**



Primed to Clean

REAL TIME SERVICE

READY TO RESPOND

There's no time for downtime in your operation. That's why our products are designed to facilitate quick turnarounds and replacements.

By easing access to spare parts through our **real time app**, Comenda ensures rapid response and complete client service. For support, count on our extensive network of distributors and service providers who are ready to assist when you need us.



01

Simply scan the QR code that features on all our machinery to gain 24/7 access to our service platform.

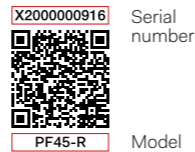

Serial number
Model



02

Tap into user manuals as well as detailed electrical and hydraulic schematics, and exploded views.



03

Original spare parts can be easily ordered by clicking on the exploded view.

Machine spec sheets and CAD drawings are available online in the Comenda Library section at www.comenda.eu

Primed to Clean

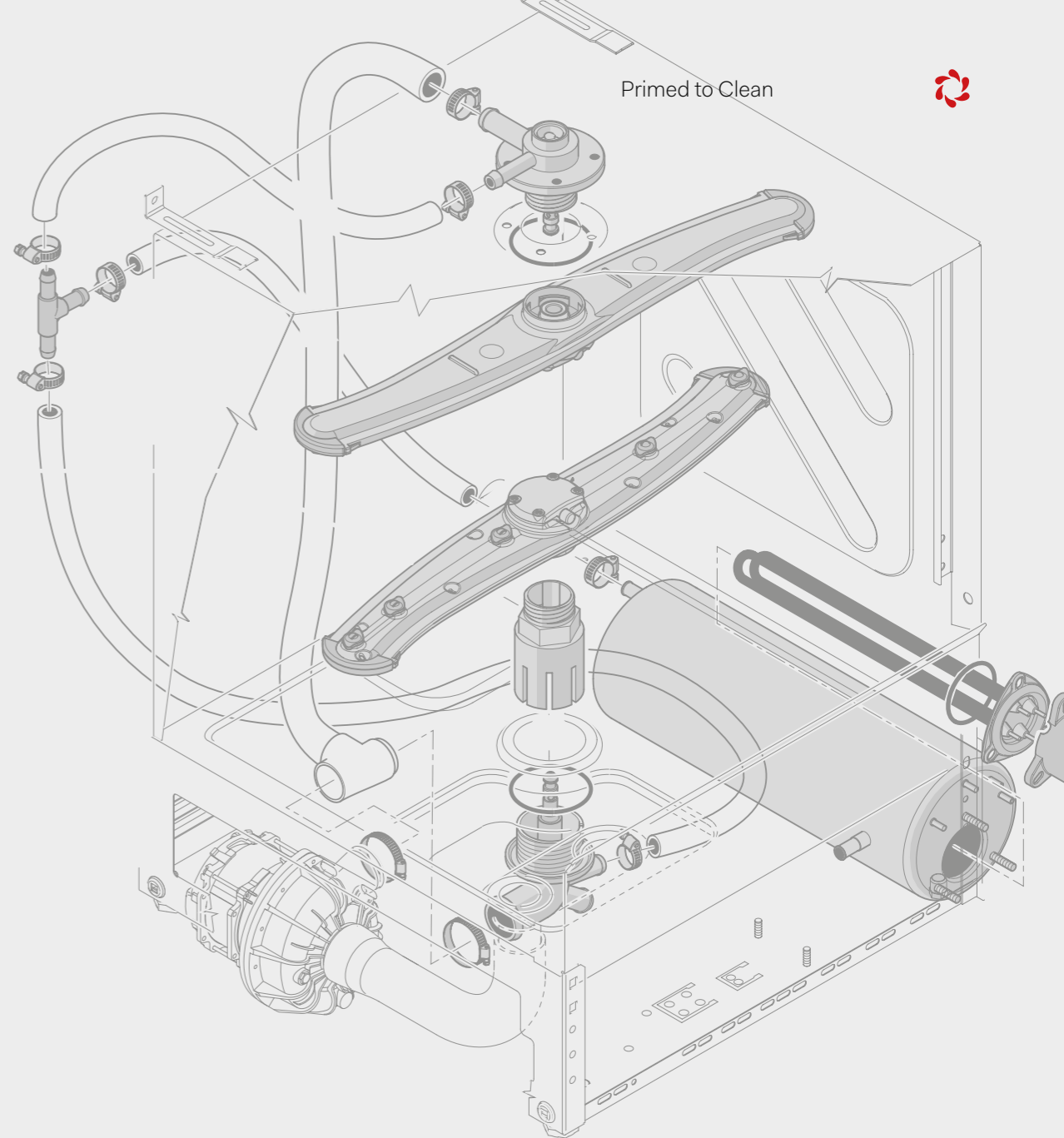

RESEARCH & DEVELOPMENT

A CONTINUOUS CYCLE OF IMPROVEMENT

We have a responsibility to push ourselves to improve. Every detail of Comenda equipment undergoes ongoing scrutiny, testing and refinement.

Through our Research & Development team and certified on-site lab we uphold rigorous scientific principles to develop proven solutions. We draw on the expertise of multidisciplinary engineers and steel industry professionals along with an extensive network of sales managers and distributors who clearly understand client challenges to ensure our equipment performs to the highest calibre.

Teamed with our ongoing customer consultation we can directly address specific issues. That approach may exceed common expectations in this industry, but it demonstrates our commitment to providing superior client service and a stronger overall relationship.





COMPANY

COLLABORATIVELY COMENDA

Just as you are in the business of serving people, we're in the profession of serving you.

Our development since 1963 as a company has always championed exceptional performance, cost containment and highly energy efficient design. Close, active consultation also ensures that we generate the perfect solution for our clients. That involves understanding the challenges our clients face on a daily basis and helping them to meet their objectives.

That's the Comenda difference and it carries on through our commitment to ongoing service and support.

We may be just one component of your overall success, but we always aim to be at the heart of your operation.





PRODUCT SPECIFICATION

PRIMED TO CLEAN

PB Glasswashers PB24 PB24 A PB34 PB34 A	PF Undercounter multipurpose units PF45 PF45 R PF45 RA PF46 R	PC Pass through units PC07 PC07 R PC07 RA PC09 PC09 R PC09 RA PC12 PC12 R PC12 RA
--	--	---

PRODUCT NOMENCLATURE

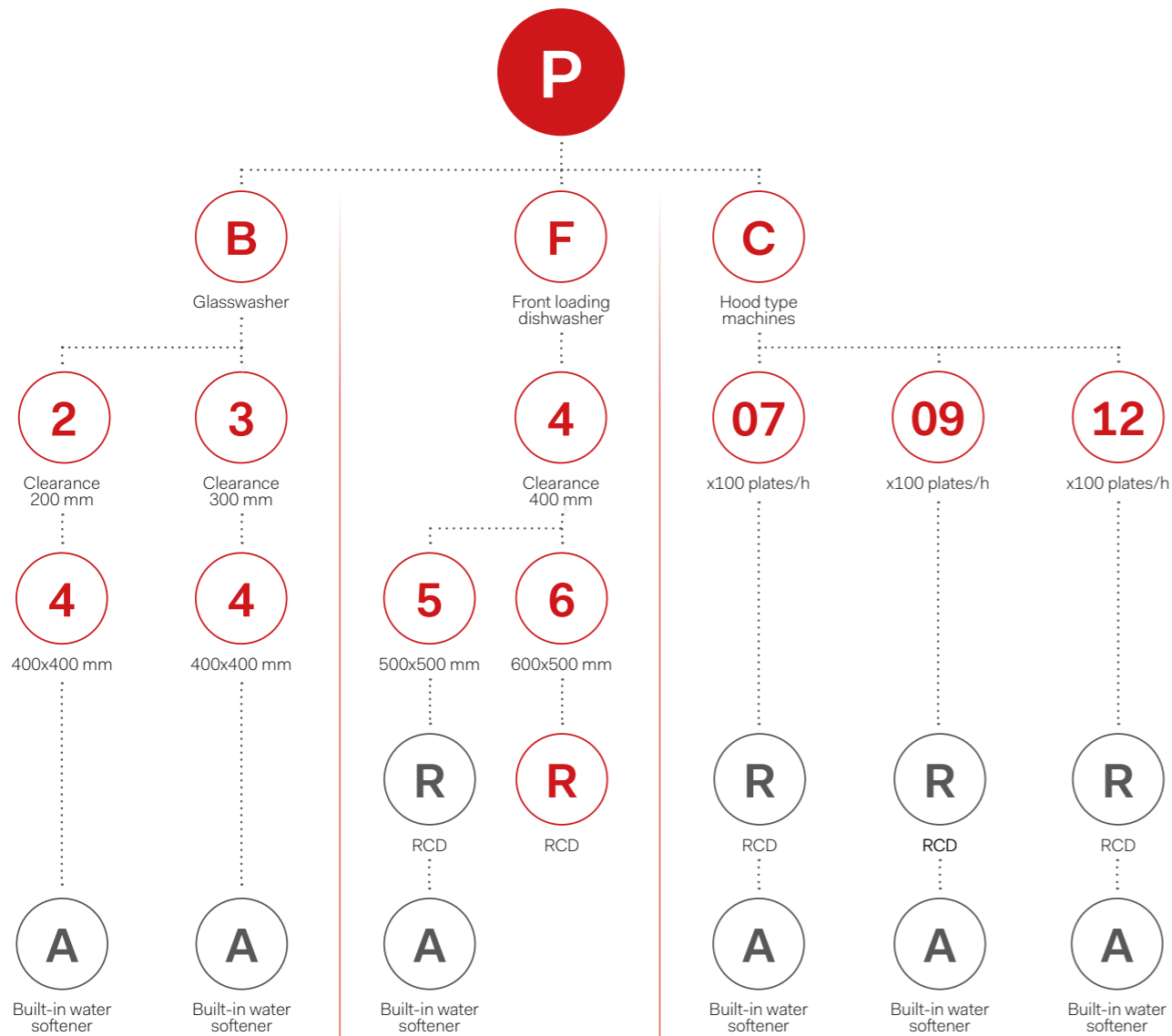

PB Glasswashers

DIMENSIONAL DATA

	EXTERNAL DIMENSIONS (LxDxH mm)	RACK (mm)	CLEARANCE* (mm)	NET WEIGHT (Kg)
PB24 PB24 A	460x521x618	400x400	220	36
PB34 PB34 A	460x521x668		270	37

TECHNICAL DATA

	POWER SUPPLY (V)	MAX OUTPUT** (rack/h)	RINSE WATER CONSUMPTION (l)	BOOSTER CAPACITY (l)
PB24 PB24 A	230V ~ 50HZ	40	2,5	4,4
PB34 PB34 A				

	TANK HEATHER (kW)	BOOSTER HEATHER (kW)	WASH PUMP (kW)	INSTALLED LOAD (kW)	TANK CAPACITY (l)
PB24 PB24 A	2	2,4	0,26	2,66	12
PB34 PB34 A					12

WASH PROGRAMS LENGHT (sec)

	ECO FAST	GLASSES DIN10511	DISHES DIN10510	INTENSIVE
PB24 PB24 A	76	71	102	222
PB34 PB34 A	76	71	102	222

OPTIONAL

	PB24	PB24 A	PB34	PB34 A
DRAIN PUMP	•	•	•	•
STAINLESS STEEL WASH AND RINSE ARMS	•	•	•	•
DETERGENT DOSING PUMP	•	•	•	•



- Single skin body stainless execution AISI 304
- Molded double skin insulated door
- Built in rinse aid dosing pump
- Provision for detergent dosing pump connection.

* Maximum passage height rack included.

** The theoretical output refers to the unit connected to 55 °C incoming water temperature and max total installed power.

Cod. 900920EN02.1B - We reserve the right to modify technical features, pictures and graphics.



PF

Undercounter multipurpose units

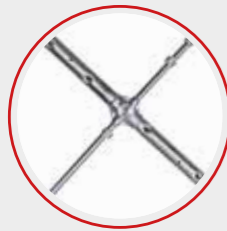

Stainless steel rotating wash and rinse arms. Standard

PF46 R

DIMENSIONAL DATA

	EXTERNAL DIMENSIONS (LxDxH mm)	RACK (mm)	CLEARANCE* (mm)	NET WEIGHT (Kg)
PF45 PF45 R PF 45 RA	600x626x825	500x500	360	58
PF 46 R	600x695x830	500x600	400	66

TECHNICAL DATA

	POWER SUPPLY (V)	MAX OUTPUT** (rack/h)	RINSE WATER CONSUMPTION (l)	BOOSTER CAPACITY (l)
PF45 PF45 R PF 45 RA	Multipower 230V ~ 50Hz 230V 3 ~ 50Hz 400V 3N ~ 50Hz	40 / 60***	2,5	7,5
PF 46 R		40	3,2	

	TANK HEATHER (kW)	BOOSTER HEATHER (kW)	WASH PUMP (kW)	INSTALLED LOAD (kW)	TANK CAPACITY (l)
PF45 PF45 R PF 45 RA	2	5 / 7***	0,45	5,45 / 7,45***	21
PF 46 R		7	0,83	7,83	23

WASH PROGRAMS LENGHT (sec)

	ECO FAST	GLASSES DIN10511	DISHES DIN10510	INTENSIVE
PF45 PF45 R PF 45 RA PF 46 R	76	71	102	222

OPTIONAL

	PF45	PF45 R	PF45 RA	PF46 R
DRAIN PUMP	•	•	•	•
WRIS®2 STAINLESS STEEL WASH AND RINSE INTEGRATED SYSTEM	•	•	•	○
DETERGENT DOSING PUMP	•	•	•	•
BASE STAND C/W DOOR AND ADJUSTABLE FEET	•	•	•	•



- Single skin body steel stainless AISI 304
- Molded double skin insulated door
- Built-in rinse aid dosing pump
- Provision for detergent dosing pump connection

* Maximum passage height rack included.

** The theoretical output refers to the unit connected to 55 °C incoming water temperature and max total installed power.

*** Optional. 60 racks/h max output with 7 kW boiler heating element.



PC

Pass through units



Stainless steel rotating wash and rinse arms. Standard

PC09
PC12

DIMENSIONAL DATA

	EXTERNAL DIMENSIONS (LxDxH mm)	RACK (mm)	CLEARANCE* (mm)	NET WEIGHT (Kg)
PC07, PC07 R PC07 RA	624x740x1460	500x500	440	108
PC09, PC09 R PC09 RA				123
PC12, PC12 R PC12 RA				126

TECHNICAL DATA

	POWER SUPPLY (V)	MAX OUTPUT** (rack/h)	RINSE WATER CONSUMPTION (l)	BOOSTER CAPACITY (l)
PC07, PC07 R PC07 RA	Multipower 230V ~ 50Hz 230V 3 ~ 50Hz 400V 3N ~ 50Hz	40	2,5	8,2
PC09, PC09 R PC09 RA		48	2,8	
PC12, PC12 R PC12 RA		65		

	TANK HEATHER (kW)	BOOSTER HEATHER (kW)	WASH PUMP (kW)	INSTALLED LOAD (kW)	TANK CAPACITY (l)
PC07, PC07 R PC07 RA	2,2	7	0,7	7,7	42
PC09, PC09 R PC09 RA	3	9	1,1	10,1	
PC12, PC12 R PC12 RA			1,5	10,5	

WASH PROGRAMS LENGHT (sec)

	ECO FAST	GLASSES DIN10511	DISHES DIN10510	INTENSIVE
PC07, PC07 R PC07 RA	76	71	102	222
PC09, PC09 R PC09 RA	61	71	102	222
PC12, PC12 R PC12 RA	41	71	102	222

OPTIONAL

	PC07, PC07 R, PC07 RA	PC09, PC09 R, PC09 RA	PC12, PC12 R, PC12 RA
DRAIN PUMP	•	•	•
CRC2 HEAT RECOVERY UNIT AND STEAM CONDENSER	•	•	•
DOUBLE SKIN INSULATED HOOD	•	•	•
WRIS®2 STAINLESS STEEL WASH AND RINSE INTEGRATED SYSTEM	•	○	○
STRAIGHT AND CORNER CONFIGURATION	•	•	•

- Single skin body, stainless steel execution AISI 304
- Hood activated cycle start and manual cycle start
- Removable rack holder

- Single piece deep drawn tank; multiple filtration system (whole tank filter and pump suction filter)
- Built in rinse aid dosing pump
- Provision for detergent dosing pump connection

* Maximum passage height rack included.

** The theoretical output refers to the unit connected to 55 °C incoming water temperature and max total installed power.

Cod. 900920EN02.1B - We reserve the right to modify technical features, pictures and graphics.

Cod. 900920EN02.1B - We reserve the right to modify technical features, pictures and graphics.

CONTACT

Comenda

Via Galileo Galilei 8
20060 Cassina de' Pecchi (MI)
Italy
P +39 02 952281

sales@comenda.eu
www.comenda.eu



-

CONCEPT & ART DIRECTION

Hangar Design Group
www.hangar.it



Comenda complies with ISO9001 quality management system and ISO14001:2015 environmental management system.



an Ali Group Company



The Spirit of Excellence